



Explosion Proof H Series

LED Linear Light



Model H2

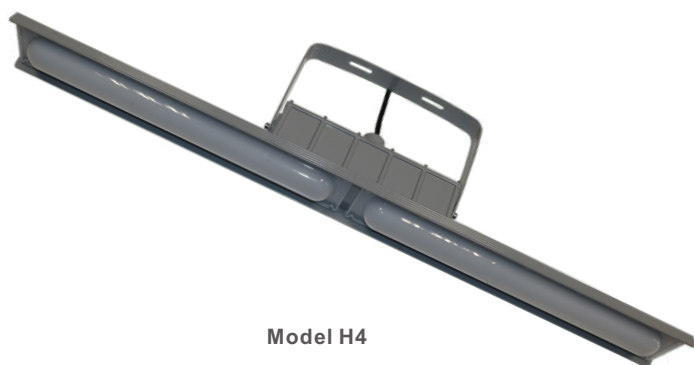

Model H4

Materials

- ★ Housing: Die-casting aluminum
- ★ Diffuser: PC
- ★ Bolts: Stainless steel
- ★ Mounting Bracket: Stainless steel

Basic Data

Product Number	Wattage	Color Temperature	Voltage	Lumens	Warranty	CRI
EX-20W H2YZDA	20	2200K-7000K	AC100-277V	2800	5 years	80
EX-40W H2YZDA	40		IC 100-277V	5600		
EX-40W H4YZDA	40		AC 200-488V	5600		
EX-60W H4YZDA	60		DC 12-48V	8400		
EX-80W H4YZDA	80			11200		

“H2, H4”=Product code “Y”=D or N: Dimmable or Non-dimmable “Z”=CCT, from 2200~7000K “D”=Beam angle, D120 for 120°. A for cover info. blank for flat cover, C spherical cover.

Explosion Protection

Marking Atex	II3 G Ex ec IIC T5/T6 Gc II2 D Ex tb IIIC T80/100°C Db IP66
Marking IECEX	Ex ec IIC T5/T6 Gc Ex tb IIIC T80/100°C Db IP66
Marking UL844 (North American)	Class I, Division 2, Groups A, B, C, D Class II, Division 1, Groups E, F, G Class II, Division 2, Groups F, G Class III
Marine Marking	UL 1598A ABS
Other Rating	IP 66

Applications

Oil and Gas industry

- ★ All petroleum production and refining
- ★ Petroleum loading and transportation
- ★ Petroleum storage and retail
- ★ LNG industry
- ★ All mining operations and service

Chemical industry

- ★ All types of painting facilities
- ★ Chemical production and storage

Ocean, marine and aerospace field

- ★ Ocean platform operation facilities and structure
- ★ Aerospace clean room and production
- ★ Ocean vessel operations

Metal treatment

- ★ Steel and aluminum factories
- ★ Pumping stations in any environment
- ★ Metal smelting, foundry and manufacturing

Food and alcohol industry

- ★ Flour and fine particle production and storage
- ★ Food and distilling production
- ★ Alcohol industry

Other high humidity, dust, high temperature, vapor locations

Key Features

- High quality SMT LED and Meanwell Driver.
- Light-weight design by aircraft aluminum.
- Heavy-duty and high impact resistance.
- Three connection cable entry points.
- Replaceable LED board and drivers.
- Integrated junction box for driver.
- Dimmable and battery back up function available.
- Marine rating powder coated appearance treatment.
- High energy efficiency.
- 2 versions with different size.

Value-Added Features

- 10kv surge protection.
- Up to ten years limited warranty option.
- Emergency Battery back up (Option).
- Various installation ways for different applications.
- Polycarbonate diffuser to make wider beam angle.
- Customized motion sensor (Option).
- Advanced smart system options: WIFI & BLUE-TOOTH (Option).

Mechanical Structure

Unit: mm or inch

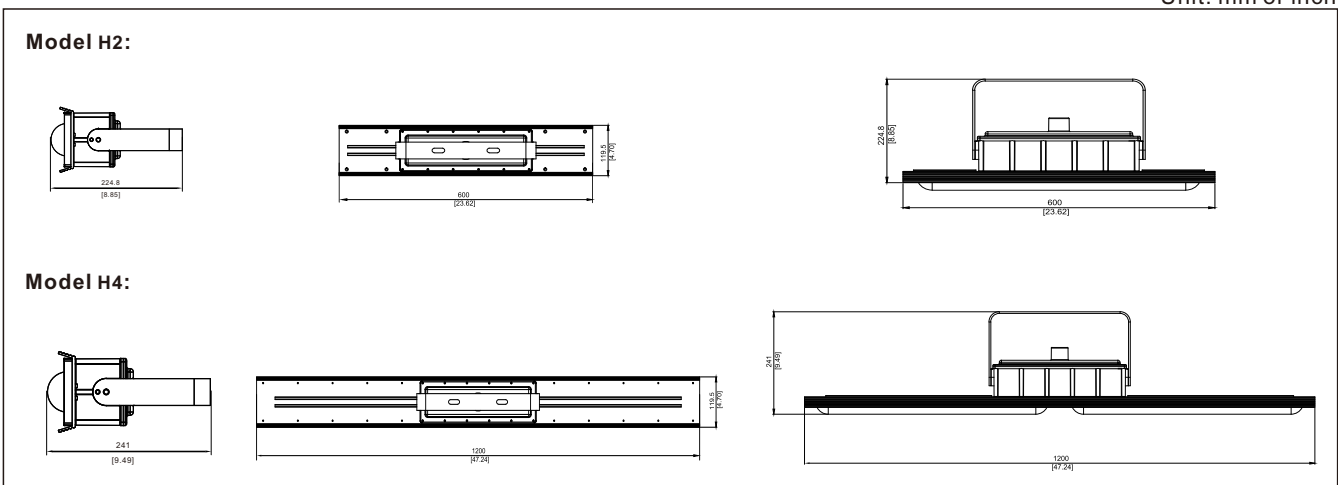

This structure type with bracket and PC diffuser to generate 120° light distribution.

Lighting Distribution

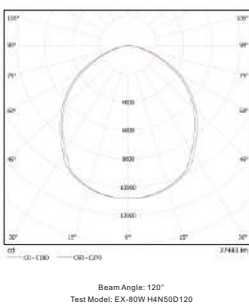

Installation Manual

WARNING

READ INSTRUCTIONS CAREFULLY BEFORE INSTALLATION. KEEP THIS INSTRUCTIONS FOR FUTURE REFERENCE.
Fixtures must be wired in accordance with the National electrical code and all applicable local codes. Proper grounding is required for safety.

THIS PRODUCT MUST BE INSTALLED IN ACCORDANCE WITH THE APPLICABLE INSTALLATION CODE BY QUALIFIED ELECTRICIAN WHO IS FAMILIAR WITH THE CONSTRUCTION AND OPERATION OF THE PRODUCT AND THE HAZARDOUS INVOLVED.

Warning: Risk of fire or electric shock. Emergency light installation requires knowledge of luminaires and electrical systems. DO NOT open the enclosure when energized. DO NOT try to install if not qualified. Please contact a professional electrician.

Warning: Risk of fire or electric shock. Suitable for wet locations. Make sure the power is off prior to installation.

Warning: Risk of fire or electric shock. Suitable for non-insulated surface and frame. DO NOT cover fixture with insulation liner or similar material.

Warning: DO NOT install in unstable, loose or breakable surfaces.

Warning: DO NOT let objects impact or exert force on the surface of the fixture.



⚠ WARNING
Risk of fire, Electric shock or personal injury
Please turn off power before installation!

Bracket Mounting

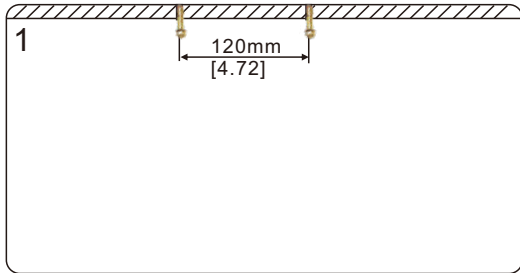

1. Drill 2x Ø10 holes for expanded screws, and then fix them to the ceiling.

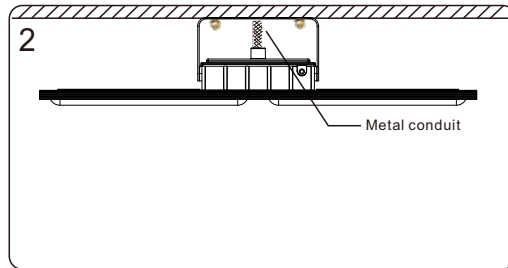

2. Install the fixture to the expanded screws, and tighten the nuts. (Metal conduit need to apply here)

Pole Bracket Mounting

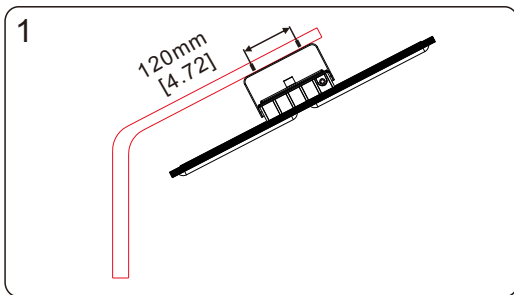

1. Drill 2x Ø10 holes for fixing screws.

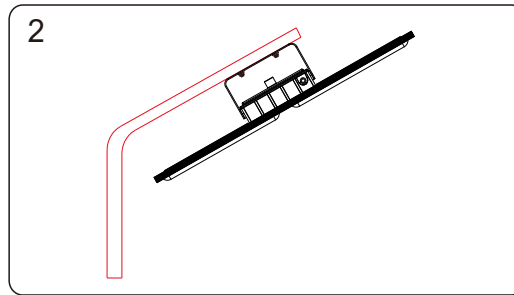

2. Insert 2x Ø10 fixing screws and weld them on the pole bracket with the fixture.

Wall Mounting



1. Drill 2x Ø10 hole for expanded screws, and fix them to the wall. (Horizontal distance: 171mm)

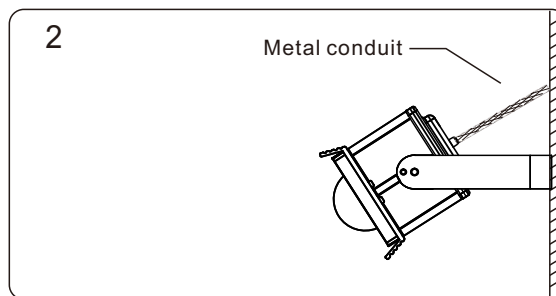

2. Install the fixture to wall and connect the wire to AC power. (Metal conduit needs to apply here)

Packing Information

Model	Quantity/Ctn	Length(cm)	Width (cm)	Height(cm)	Net weight(kg)	Gross weight (kg)
H2	2	69.1	41.3	29	4	9
H4	2	130	40	29.5	5.5	14.5

Accessories



● Model: Ex-Junction01
Name: Junction Box
Material: Aircraft Aluminum A383



● Model: EX-Hook
Name: Installation Hook
Material: Aircraft Aluminum A383



● Model: Ex-Conduit01
Name: Metal Conduit
Material: Stainless Steel and Aluminum



● Model: EX-WPipe
Name: Winding Swing Pipe
Material: Iron with Power Coating



● Model: EX-SPipe
Name: Winding Swing Pipe
Material: Iron with Power Coating



● Model: Ex-D01
Name: Pendant Direction Adapter
Material: Aircraft Aluminum A383



● Model: EX-MArm
Name: Surface Mounting Arm
Material: Aircraft Aluminum A383



● Model: EX-25PSupport
Name: 25 Degree Pole Support
Material: Aircraft Aluminum A383



● Model: EX-90PSupport
Name: 90 Degree Pole Support
Material: Aircraft Aluminum A383



● Model: Ex-90JSupport
Name: 90° Arm to Junction box
Material: Aircraft Aluminum A383



● Model: Ex-25JSupport
Name: 25° Arm to Junction box
Material: Aircraft Aluminum A383



● Model: Ex-DArm
Name: Direct Mounting Arm
Material: Aircraft Aluminum A383



● Model: Ex-PCH
Name: Pendant Chain
Material: Stainless Steel S30400